

Installation Guide

Cladding Boards

Disclaimer: Consult your local building code to ensure your project is installed in accordance with local requirements. Also, consult your local building office to understand permitting requirements. Drawings and schematics used to show where to place screws and nails are for reference purposes only. Safety glasses and a dust mask should always be worn when working with **TIMBRA Tech**[®] products. Drilling, sawing, sanding, or machining wood products generates wood dust. Avoid inhaling wood dust or use a dust mask or other safeguards for personal protection.

1.

Storage

Whenever possible, store **TIMBRA Tech**[®] cladding boards outdoors. The cladding should be kept away from direct sunlight, as UV rays will cause the colour to fade. If stored outside, ensure the boards are elevated at least 150 mm from the ground, stacked evenly, and covered with a waterproof, light-impermeable cover. Leave the ends of the cover unfastened to allow ventilation, preventing moisture damage. **TIMBRA Tech**[®] cladding should never be left in the rain or exposed to excess moisture when in its original packaging, as it will not dry properly when tightly packaged. If possible, store the boards at the installation site for a few weeks prior to installation to allow them to acclimatize to the moisture conditions, using a protective cover to prevent moisture damage.

2.

Building a Proper Support Structure and Avoiding Moisture Damage

- **IMPORTANT:** Check the boards thoroughly for any manufacturing or moisture defects, as well as transport-related damage, prior to installation. Do not install defective boards.

ONCE INSTALLED, PRODUCTS ARE DEEMED TO HAVE BEEN ACCEPTED IN TERMS OF QUALITY.

Allow for 10 percent wastage when purchasing.

Support Structure

- ✦ **TIMBRA Tech**[®] cladding should be applied only on adequate structures, both regarding support capacity and design, ensuring no detrimental influence to occur.
- ✦ We recommend ensuring that the dimensional stability of the **TIMBRA Tech**[®] products used (± 3 to 7%) befit the climate at the installation site.
- ✦ Proper ventilation and rainfall drainage should be ensured to avoid accumulation and undesired accelerated degradation.
- ✦ Ensure that a proper humidity barrier is applied to the substrate surface upon which the installation is to be applied, to avoid undesired absorption of water content.
- ✦ The installation of **TIMBRA Tech**[®] products should follow the recommendations for materials and fixtures, such as spacing and fastening methods, set by **TIMBRA Tech**[®], and in accordance with local regulations, for each application.
- ✦ Always take into consideration that profile geometries can influence how these are suitable to be mounted/applied (see types of orientations in Fig 1).

Cladding Orientation

The orientation of cladding elements has a direct impact on the aesthetics and character of a building's facade. Beyond visual appeal, it also influences how sunlight, rain, and other environmental factors interact with the wood.

Explore the main installation options for **TIMBRA Tech**® thermally modified wood cladding:

Horizontal Installation

This is the most traditional layout. Boards are installed parallel to the ground, creating a sense of stability and visual width. A versatile choice that complements a wide range of architectural styles, it conveys balance and solidity.

Vertical Installation

Here, boards are installed perpendicular to the ground. This orientation enhances vertical lines, adding elegance and a sense of height. Ideal for projects aiming for a more refined and lightweight appearance, it requires special attention to joint detailing for proper water resistance. Some profiles are better suited for vertical use consult the **TIMBRA Tech**® team for guidance.

Diagonal or Angled Installation

A bold and distinctive approach. Installing cladding at an angle creates movement and a dynamic look on the facade. While it delivers a unique aesthetic impact, this orientation requires precise cutting and expert detailing.

Climate Conditions & Functionality

When defining the orientation of **TIMBRA Tech**® thermally modified cladding, consider the architectural style, desired visual effect, and local climate. Some orientations naturally promote water drainage and reduce moisture retention. Consulting with architects and technical professionals is essential to achieving the best balance between visual expression and technical performance.

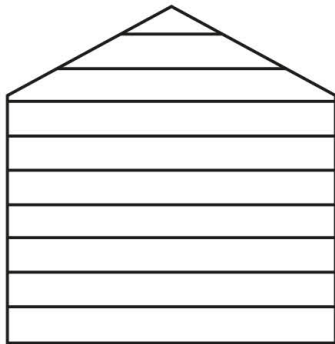

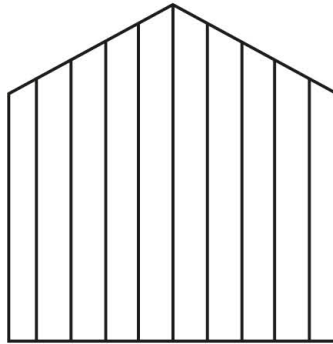

Horizontal

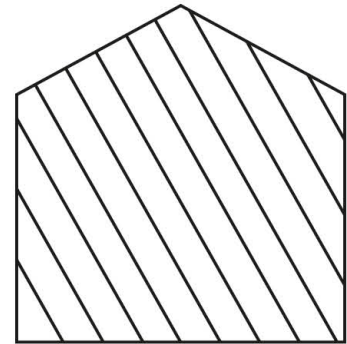

Vertical



Diagonal

- 
 When considering applications of **TIMBRA Tech**[®] products for cladding, if high rainfall is expected to take place, avoidance of horizontal and diagonal orientations of the boards is recommended.
- 
 Ensure that the distribution of the support battens is in accordance with the needs and regulations applicable.
- 
 Proper wood battens support structure should be used for cladding installation (see fig). Battens should be properly fixed to the underlying wall/structure, being it wood or wood based material, concrete or other.

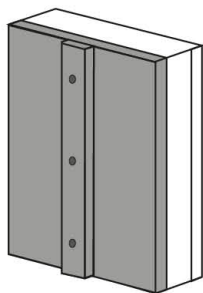

Timber Structure - Timber
 Frame or CLT

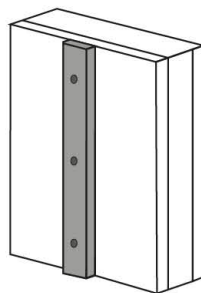

Concrete Structure -
 Masonry

Support Structure arrangements

Orientation of the Installation

Vertical

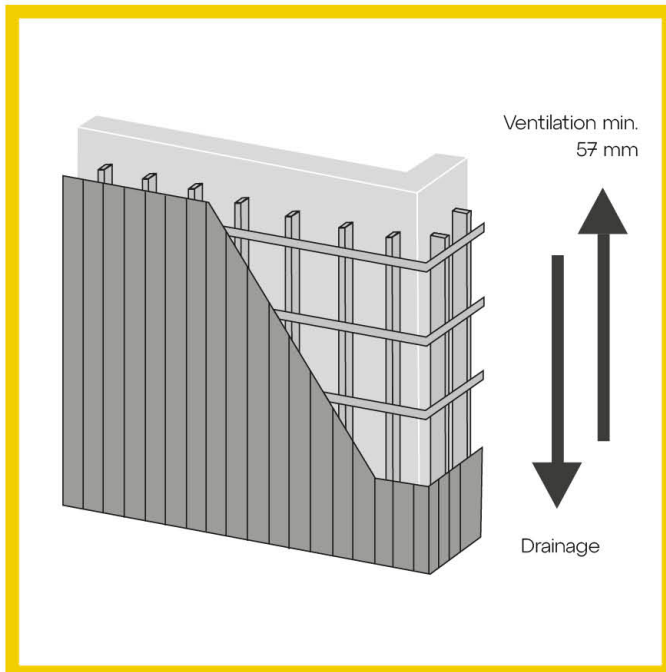

- Overlaid cross batten arrangement;
- The maximum recommended distances between both the vertical and horizontal wooden battens is 600 mm;
- The wooden battens should allow for a minimum 35 mm of ventilation gap;
- The horizontal battens should be applied with a slight angle ($< 20^\circ$) in order to avoid water accumulation.

Horizontal

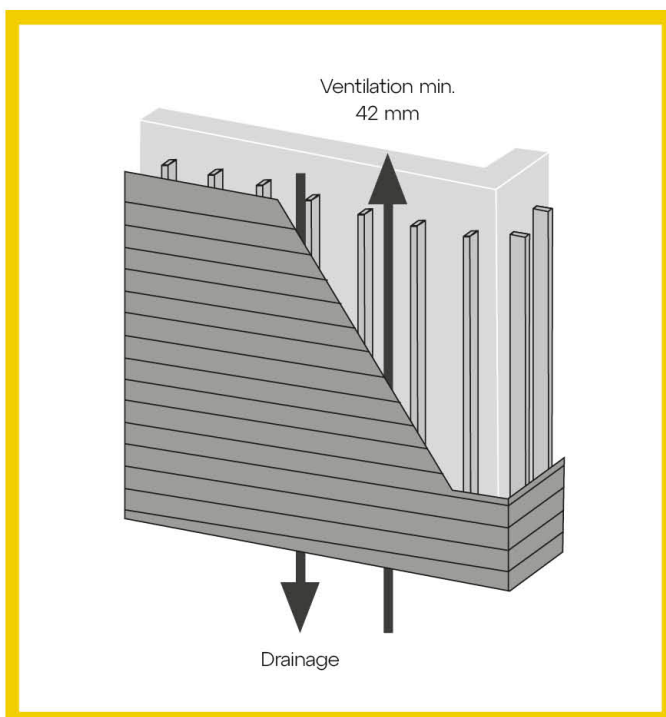

- Vertical single batten arrangement;
- The wooden overlaid battens should allow for a ventilation gap of at least 70 mm.

Diagonal

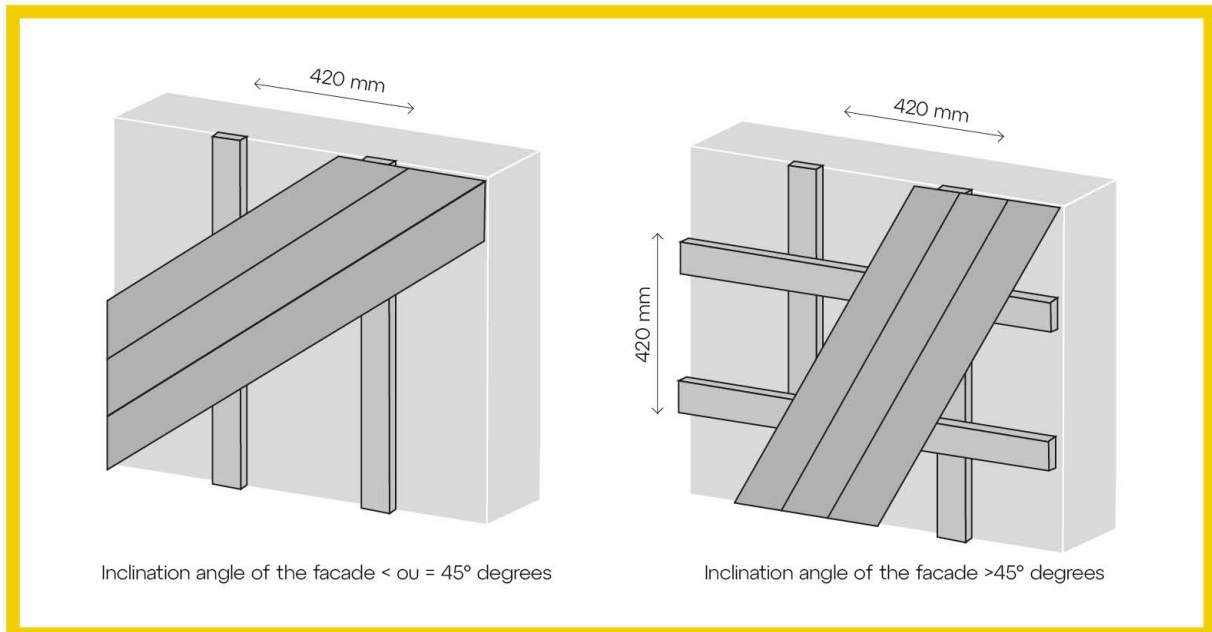

- In the applications for which the wood profiles are to be installed with an inclination, it is recommended that the support structure be dependent on the angle with the horizontal plane;
- For an angle less or equal to 45° a vertical-like support frame can be used, if suitable to the length of the profiles being used;
- For an angle over 45° , an horizontal-like structure is recommended, if suitable to the length of the profiles being used;
- When choosing this type of installation one must be mindful of the needs for the dimensional stability of the timber, so to ensure that the inclination and the possible variations do not compromise the integrity of the supports neither the wood profiles themselves.

Fasteners

Given the natural properties of our products, it is recommended that the fasteners used are made of stainless steel, so as to ensure that no degradation by corrosion occurs. A material class that can be recommended is A2 (EN 1.14301; AISI 304).

Installation Types and Distances

- ✦ The installation of the profiles should be performed taking into consideration both the type of profile and the desired visibility or not of the fasteners applied.
- ✦ The order and placement of the profiles which have non-parallel surfaces should be made to account for the intended natural flow of rainfall, so as to avoid retention and accumulation.
- ✦ Appropriate spacing in the length of the wood profile should be left between the edge and the nearest batten, so to avoid underived fissures which can occur when fasteners are applied to cole to the edge of de profile.

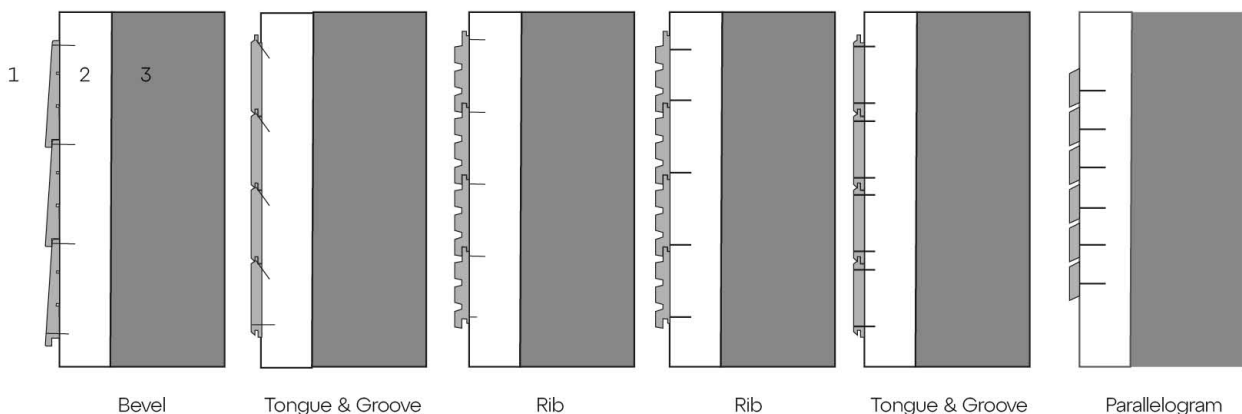

- 1 - Wood Profile
- 2 - Fixing System
- 3 - Support Wall

Be mindful to introduce the fasteners just down to the surface of the profiles, not less, not deeper than it. See fig for visual schematic representation.

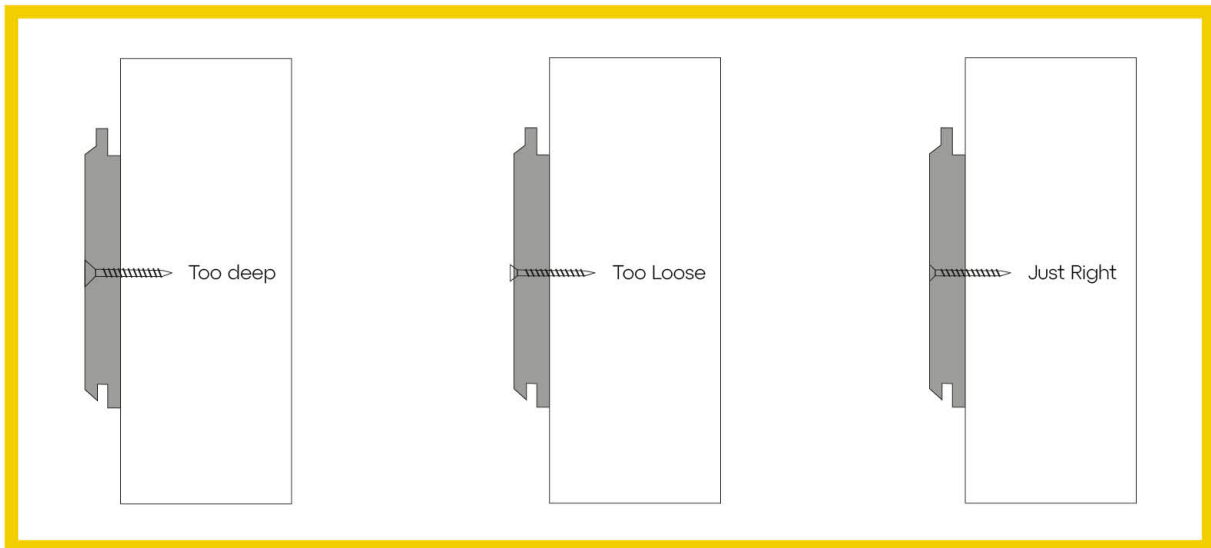

3.

Installation Click System Powered by GRAD®



TIMBRA Tech® products combine high-quality thermally modified products with the unique Grad installation system. This hidden fastening solution is designed for quick and easy installation. TIMBRA Tech® boards have grooves on the underside that perfectly fit Grad® clips or aluminium rails with pre-mounted Grad® clips. As a result, there are no visible screw heads. The boards are simply pressed and clicked into place.



Easy Installation

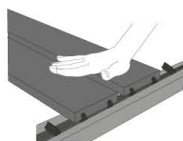

Just Press and Click



Grad Simple Click

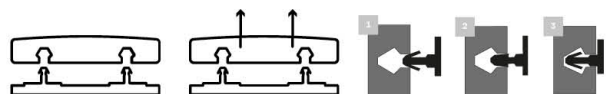

The boards click into place when depressed and it's done.

More Information: www.grad-system.com